

Owner's Manual

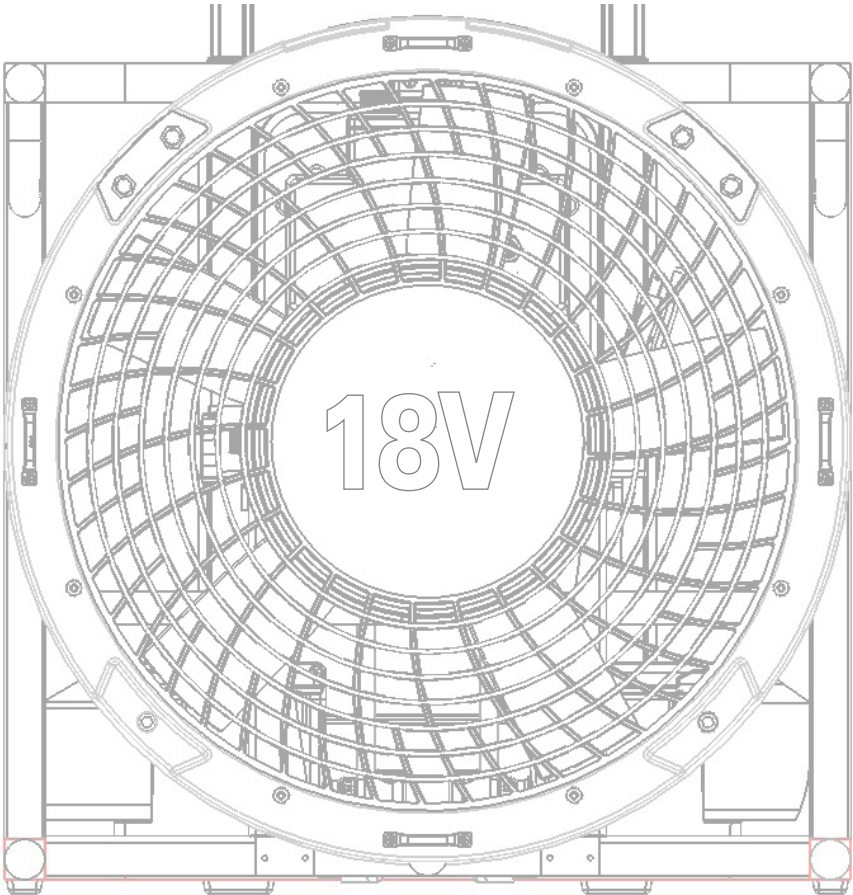

ALL PURPOSE-BATTERY VENTILATOR

READ MANUAL BEFORE STARTING FOR THE FIRST TIME!

Thank you for purchasing the RAMFAN® EX50-18V battery powered multi-purpose ventilator manufactured in the USA by Euramco Group, Inc.

For more than 50 years Euramco Group has been on the cutting edge of industrial, fire, and marine ventilation products. Each of our blower/exhausters, PPV & LSV fans and accessories represent the finest technologies available. Every product is constructed to demanding and exact specifications for quality, performance, and reliability.

When human life depends on having a fan that can deliver clean, safe air, you have only one choice you can trust: RAMFAN.

Explore our website and online catalog at www.ramfan.com and discover how RAMFAN can make a difference in the field!

All product information in the publication is based on the most current information available at the time of printing. Euramco Group, Inc. reserves the right to make changes at anytime without notice.

RAMFAN products are warranted against manufacture defect. Failure to properly maintain product will invalidate warranty coverage. Please visit www.euramco.com for warranty details.

PRIOR TO FIRST USE

1. Operate on AC voltage, 85-264V, 50/60 Hz 1Φ, for charging and discharging.
2. The unit is suitable for use on Ground Fault protected circuits.
3. Should the provided AC connector be unsuitable, replace with desired connector containing a grounding circuit. Check continuity from ground terminal to motor shell.
4. This fan is for emergency service use. Charge fully between runs. Create a charging protocol.
5. For DC operation with AC disconnected, hold the wake button until indicator lights come on showing battery state. Advance speed control.
6. For AC operation, advance speed control.



CONTENTS

Unit Description	4
Warning Labels & Safety Precautions	5
Specifications	5
Main Interface	6
Adjusting Angle	7
Operational Modes	8
AC Operation	8
DC Operation	8
Connection of Battery Pack	8
Battery Operation Procedures	8
Run Time	9
Battery Status Indicator Lights	9
AC Power Cord	10
Maintenance and Disposal	11
Maintenance Schedule	12
Accessories	13
Plug Types	14
Certification	15

Unit Description

The EX50-18V is a multi-purpose ventilator powered by battery(s) or single phase AC. The flexible frame configuration allows for PPV, Smoke Ejector or ducted blower use in both normal, horizontal and hanging positions.

The motor is a variable-speed BLDC motor controlled by a microprocessor integrated with a power supply.

The EX0-18Vi will run with battery packs.

AC voltage can be applied while running on batteries and the ventilator will auto-switch to AC power. Conversely, the AC power can be removed and the unit will auto-switch to battery power, if sufficient charge remains.

The integrated controller is EMI-protected to prevent interference with radio communication.

A simple Control Panel on the top of controller controls all functions.

Warning Labels & Safety Precautions

- Electrical shock hazard. Do not open enclosures.
- **DO NOT START** with signs of visible damage.
- Blower is not intended for operation in explosive atmospheres.
- Wear ear protection when close by.
- Keep body parts and loose objects away from intake of fan.
- Do not move while running.
- Operate and repair by trained personnel only.
- Always use grounded plug and properly ground AC power receptacle.
- Heat sink becomes hot during operation and charging.
- Use with approved, good condition extension cord with ground connector.



Wire Gauge Requirements per ft (m)	
0-150 ft (0-50m)	AWG 14 (2.5 mm ²)
>150 ft (> 50m)	AWG 12 (4 mm ²)

Specifications

Model	EX50=18V 18"/46 cm	
Order#	EL5518D / EL5518M	
Motor	1hp BrushlessPPV™	
Runtime @ Max. Speed	DC: 40 minutes - 12Ah Batteries 50 minutes - 15Ah Batteries AC: Unlimited	
Power AC	Universal Input: 85-264V 1Φ, 50/60 HZ	
Battery System	18V, 240Wh / 12Ah Milwaukee 20V, 240Wh / 15Ah DeWALT	
Dimensions (h x w x d)	22 x 21 x 16 in / 56 x 53 x 41 cm 22 x 21 x 12 in / 56 x 53 x 30 cm (wheel kit removed)	
Weight	with one battery: 50 lbs / 23 kg	
Operating Temp Range	-4°F to 105°F	-20°C to 40°C
Tilt	-10° to + 34°	
Approvals	CE AMCA	
AMCA Verified Airflow		
DC Power Supply	10,120 cfm (17,194 m ³ /hr)	

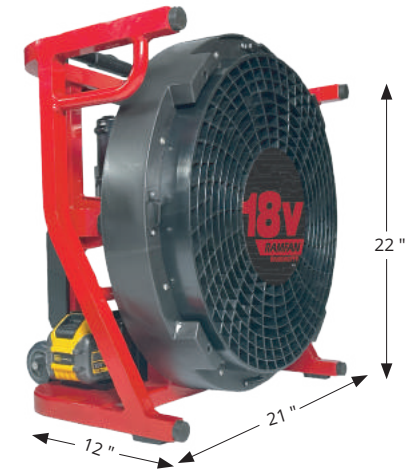

Main Interface

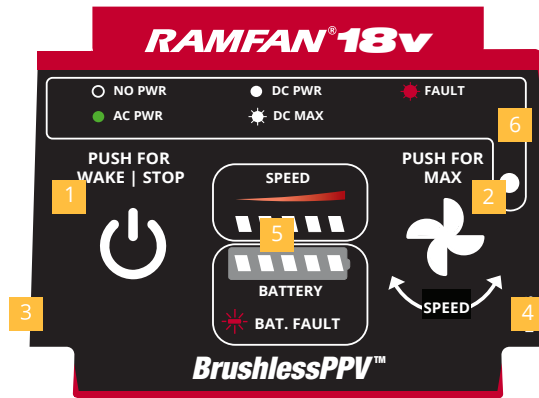

Number	Symbol	Indicate Function
1		Wake Button / Emergency Stop Button Press and hold WAKE button to start.
2		Maximum Speed (DC) Button Press MAX button for 2 seconds.
4		Speed Control knob Controlled operation from 0 to full speed
5		Battery status LED lights
6		Ventilator Status LED Lights See table below for details.
7		Speed status LEDs

Color	Status	Description
Off	NO PWR	Power is off
Green (Solid)	AC PWR	Ventilator is connected on AC Power Supply
White (Solid)	DC PWR	Ventilator is running on DC Power Supply
White (Flashing)	MAX	Ventilator is running on Maximum speed - DC Power Supply
Red (Flashing)	FAULT	Fault on the ventilator

Adjusting Angle

Perform this procedure to adjust the position of the ventilator. Use your hand to unscrew the tilt adjustment knob, and then lock it in place from above, and held in the inclined position by tightening the knob. For negative tilt, use the negative tilt bracket. This provides tilt up/down adjustment, from -10 to +34 degrees.

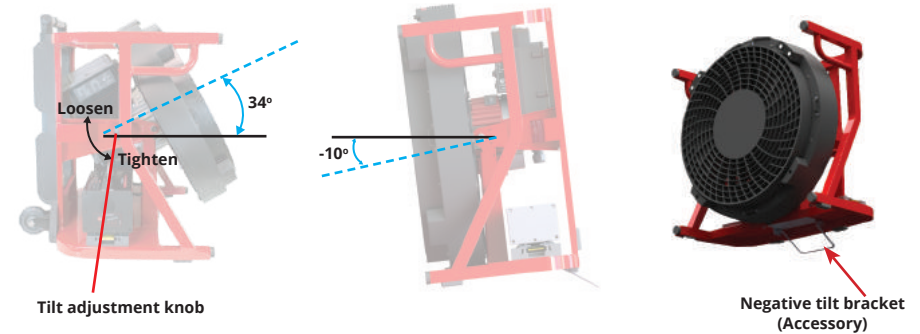

For confined space rescue operations, you can place the ventilator directly on top of a manhole. Tilt range from -90 to +90 degrees. Note that those positions can direct airflow downward or upward



Operational Modes

AC Operation

- Input Voltage. 90-250VAC, 50/60Hz
- The ventilator is capable of operating seamlessly in countries that supply electricity at either 120V AC/60 Hz or 240V AC/50 Hz without manual adjustments by the user.
- Operation out of these limits can damage electrical components and will void the warranty.



1. Connect the fan to an AC power source.
2. Status LED Light will automatically turn green, displaying the status "Ventilator is connected on AC Power Supply".
3. Start the ventilator by using the Speed Control knob to the desired speed.

DC Operation

Connection of Battery Pack

- The fan will only operate on DC while two batteries are attached.
- Firmly slide each battery into the battery housing until a click is heard.

Battery Operation Procedures

- When AC is disconnected and Speed Control is off (speed = 0), the controller and battery(s) will enter a sleep mode to conserve the battery power after 60 minutes of no activity.
- To wake the ventilator, push and hold WAKE | STOP Button  on Control Panel. Battery Status LED Light will show white solid for the status. The unit will return to sleep mode if not used within 10 minutes.
- The ventilator starts at the lower speed = 0. Speed will vary by 11 levels - from 11 (highest) to 0 (off). Turn clockwise to increase speed. At level 11 (the highest), if keep turning the control knob clockwise, the speed will not change, it will stay at highest speed all the time. To slow down, turn counterclockwise.
- If you want to increase the speed, push and hold the MAX Button  Ventilator Status LED Light will flash white for the status.
- To STOP the ventilator, push and hold WAKE | STOP Button  on Control Panel. Battery Status LED Light will be unlit.
- Reduce run speed to minimum required to increase runtime.

Run Time

Run time refers to how long the ventilator on battery power will last under a given load. We will assume both batteries have full charge beforehand and also 100% efficiency (Read "Factors that affect Battery Life" section):

	2 Batteries	Speed Level Knob
At maximum speed	40 minutes	11
At maximum speed and Max button activated	25 minutes	Max button activated 

Battery Status Indicator Lights

On the control panel, there is one set of battery status LED lights for both batteries. The estimated remaining battery time, for both batteries, is shown.

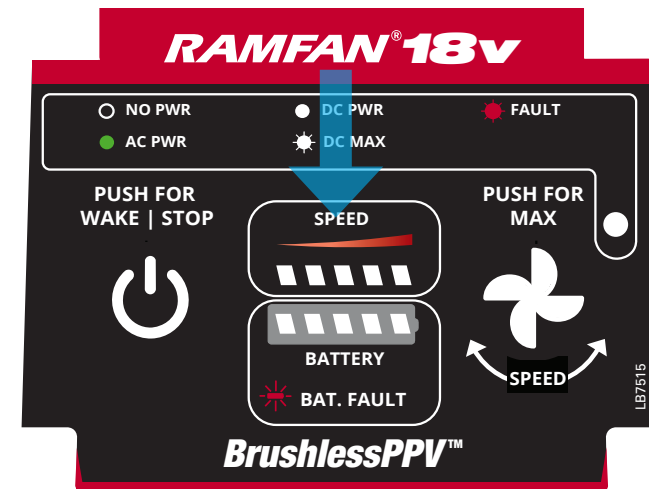

If all the lights flash red, this indicates that one, or both, batteries have failed and the battery must be replaced.

AC Power Cord

This battery fan was designed to replace corded AC fans, optimizing cordless operations. The AC power cord is designed to be removable for the convenience of those users who choose to operate cordless.

The AC power connector is a "Push-Pull" locking system where the outer (blue) slide must be pulled back, in line with the cable, to securely engage connector.

- When AC power is needed, push (blue) connector onto (black) inlet on fan controller. Check that it is securely engaged.
- When disconnecting the AC power cord from fan, pull back on (blue) slide to disengage and gently remove. Store in marked frame position when not in use.

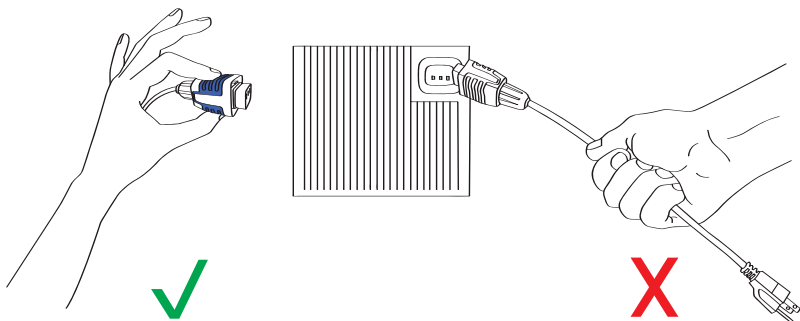

Pull the plug out itself, never by the cord or by wiggling it out of the outlet.

Maintenance and Disposal

- DO NOT disassemble the ventilator for maintenance reasons.
- Do not loosen screws on control box without contacting Euramco customer service. They are torqued to a setting to achieve water tightness.
- Completely unravel power cord and place unit on a flat, stable surface. Clean ventilator periodically to remove accumulated dust or particles from ventilator guards, impeller blade and heat sink in rear of controller (ribbed). Use only biodegradable detergents. If power washing, avoid controller housing especially gaskets and control panel.
- Contact factory for replacement parts and installation instructions. To order spare parts call Euramco Group +1.619.670.9590 or theteam@euramco.com
- Always dispose of your battery pack according to federal, state and local regulations.
- Even discharged batteries contain some energy. Before disposing of, use electrical tape to cover the terminals to prevent the battery pack from short circuit.
- Properly dispose of battery packs when necessary. Contact your local hazardous materials e-waste collection department for details or proper disposal of rechargeable batteries.

Maintenance Schedule

REGULAR SERVICE PERIOD		After Each use	Every 3 months	Every 6 months	Every year
Perform at every indicated month or operating hour interval, whichever comes first.					
ITEM					
Fan Inlet/Outlet Gaurds	Visual Check	•			
	Clean			• ⁽¹⁾	
Impeller	Visual Check	•			
	Clean				• ⁽¹⁾
Control Box Gaskets	Visual Check	•	• ⁽²⁾		
	Replace if necessary				• ⁽³⁾
Electrical Cables	Check	•			•
Rubber Feet	Check				•

(1) Clean more frequently when used in high-sediment areas.

(2) Check immediately if dropped, or damage may affect water ingress protection.

(3) These items should be serviced by your RAMFAN servicing dealer, unless you have the proper tools and are mechanically proficient. Refer to RAMFAN service manual for service procedures. Failure to follow this maintenance schedule could result in non-warrantable failures.

Accessories

1. Vehicle Mount Kit

Custom mount that perfectly fits fan
Order # EL610K

2. Integrated Rehabilitation Mister

Order # EL8111

3. HI-Expansion Foam Adapter

Foam adapter converts EX50Li into a high-expansion foam generator
Order # HI-500

4. Convert to a Smoke Ejector

Door Bar and Hangar Kit
Order # EL7095K
Hanger Kit (if you already own door bar)
Order # EL8095

5. Convert to Confined Space Rescue Fan

18"/46cm duct (16.4'/5m length)
Order # FDT-185MSR
18"/46cm duct (32.8' / 10m length)
Order # FDT-181MSR

6. Shoulder Strap

Order # EL6013

7. Rubber Feet

Rubber foot (Set of 4) + Screws for EX50Li frames

8. Mister Adapters

Double Female NH 1" Adapters
Order# WF20-0252
1" BSP TO STORZ
Order# GX-8020

Plug Types

The EX50Li is suitable for worldwide applications. Both a voltage & frequency converter is not needed. The unit includes a simple removable cord that allows the unit to operate up to 250 VAC, 50 Hz and 60 Hz:

Mainly used in	Type	Order #
North and Central America, Japan	B	EL-CUS-4762
France, Belgium, Germany, Austria, the Netherlands (and most European countries)	E/F	EL-CEU-4762
United Kingdom, Ireland, Malta, Malaysia and Singapore	G	EL-83070-4762
Australia, New Zealand, Papua New Guinea and Argentina	I	EL-84040-4762
China	I	EL-84640-4762

If it becomes necessary to use a power cord with another plug standard, order the power cord that matches the electrical requirements of the country or area. The physical adapter for the outlet is interchangeable for use in different countries and allows you to swap the cable yourself into the socket.

Certification

RAMFAN

FlowPath™ Control

AMCA

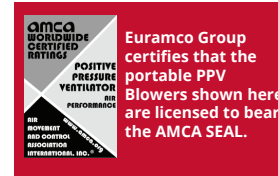

Euramco Group certifies that the Portable PPV Blower shown below is licensed to bear the AMCA Seal. The ratings shown are based on tests and procedures in accordance with AMCA Publication 211 and comply with the AMCA Certified Ratings Program.

Why We Use AMCA

AMCA, The Air Movement and Control Association International, has been in existence for nearly 80 years and is the world's only recognized authority for the development of standards and measurement of air movement.

Our commitment to AMCA Certification is your verifiable assurance that every RAMFAN PPV Turbo Blower will perform exactly as specified.

SPECIFICATIONS AND PERFORMANCE RATINGS

MODEL	SIZE		HP	DIMENSION (HxWxD)		MOTOR	WEIGHT		RPM	SETBACK		ANGLE	AIRFLOW @ FULL SPEED		POWER SUPPLY
	in	cm		in	cm		lbs	kg		ft	m		tilt	cfm	
EL5518D/M	18	46	1	22x21x12	56x53x30	BrushlessPPV™	50	22	2850	15	4.5	9°	10,352	17,588	DC

Performance certified is for installation type A - Free inlet, Free outlet.

Performance ratings do not include the effects of appurtenances (accessories).

RAMFAN's fire fighting PPV Series outperforms larger blowers in their class with their precision balanced TurboForce Impellers that maximize airflow. These PPV blowers have proven to be effective in controlling airborne contaminants, replacing interior air, removing heat and supplementing fixed ventilation systems. By pressurizing properly and controlling the resultant flow path, these changes occur very rapidly. This is accomplished by using these specialized blowers with the power and velocity to pressurize the interior of a structure or building.

May 2023



2746 Via Orange Way | Spring Valley, CA 91978 USA | (800) 472-6372 | (619) 670-9590

WWW.EURAMCO.COM

PROUDLY MADE IN CALIFORNIA

RAMFAN



SM-EX5018V
062223

USA

2746 Via Orange Way
Spring Valley, CA 91978 USA
Toll Free: (800) 472-6326
Phone: +1 (619) 670-9590
Fax: +1 (619) 670-7345
theteam@euramcosafety.com

LUXEMBOURG

1 Rue Edmond Reuter,
5326 Contern, Luxembourg
Phone: +352-621377200
Fax: +352-26008056
theteam@euramcosafety.com

MIDDLE EAST - UAE

Jebel Ali FTZ, Dubai
Phone: +1 (619) 670-9590 x114
Fax: +1 (619) 670-7345
theteam@euramcosafety.com

CHINA

A11, No. 1 Jinxi Road
Qingshuipu, Zhenhai, Zhejiang
Ningbo, China 315221
Phone: +86-574-87979390
Fax: +86-574-87979391
saleschina@euramcosafety.com