

Owner's Manual

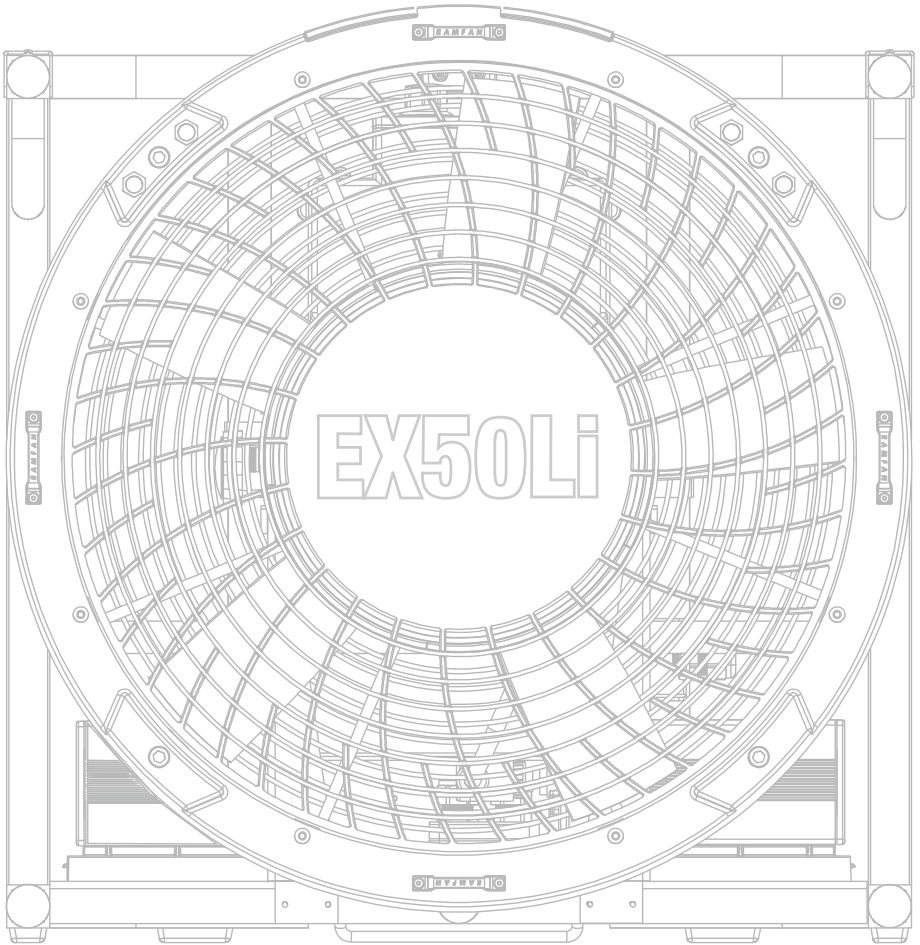

ALL PURPOSE-BATTERY VENTILATOR

READ MANUAL BEFORE STARTING FOR THE FIRST TIME!

Thank you for purchasing the RAMFAN® EX50Li battery powered multi-purpose ventilator manufactured in the USA by Euramco Group, Inc.

For more than 30 years Euramco Group has been on the cutting edge of industrial, fire, and marine ventilation products. Each of our blower/exhausters, smoke ejectors, PPV & LSV fans and accessories represent the finest technologies available. Every product is constructed to demanding and exact specifications for quality, performance, and reliability.

When human life depends on having a fan that can deliver clean, safe air, you have only one choice you can trust: RAMFAN.

Explore our website and online catalog at www.euramco.com and discover how RAMFAN can make a difference in the field!

All product information in the publication is based on the most current information available at the time of printing. Euramco Group, Inc. reserves the right to make changes at anytime without notice.



RAMFAN products are warranted against manufacture defect. Failure to properly maintain product will invalidate warranty coverage. Please visit www.euramco.com for warranty details.

PRIOR TO FIRST USE

1. Operate on AC voltage, 85-264V, 50/60 Hz 1 Φ , for charging and discharging.
2. The unit is suitable for use on Ground Fault protected circuits.
3. Should the provided AC connector be unsuitable, replace with desired connector containing a grounding circuit. Check continuity from ground terminal to motor shell.
4. Place batteries into holders and connect to IP66 connectors, Fully charge prior to first use.
5. This fan is for emergency service use. Charge fully between runs. Create a charging protocol.
6. To charge, turn the speed control fully to the left (OFF) and then connect to AC outlet. Indicator lights will illuminate, and then go off. When charging commences, indicator lights will show state of charge. Charging should complete in 3-4 hours, with the indicator lights turning green.
7. For DC operation with AC disconnected, hold the wake button until indicator lights come on showing battery state. Advance speed control.
8. For AC operation, advance speed control.

CONTENTS

Warning Labels & Safety Precautions	4
Specifications	4
Control Panel	4
Unit Description	5
Battery Operation	5
AC Operation	6
Charging	6
Battery	6-7
Maintenance	7
Maintenance Schedule	8
Operating Limitations	9
Lithium-Ion Battery Maintenance Guidelines	9
Overview	9
Rehabilitation Operation	9
Compatibility	10
Accessories	10
Certification	11
Parts Exploded View & Index	12-14
Declaration of Conformity	15

Warning Labels & Safety Precautions

- Electrical shock hazard. Do not open enclosures.
- **DO NOT START** with signs of visible damage.
- Blower is not intended for operation in explosive atmospheres.
- Wear ear protection when close by.
- Keep body parts and loose objects away from intake of fan.
- Do not move while running.
- Operate and repair by trained personnel only.
- Always use grounded plug and properly ground AC power receptacle.
- Heat sink becomes hot during operation and charging. LED lights become hot during use. Do not touch.
- Use with approved, good condition extension cord with ground connector.



Wire Gauge Requirements per ft (m)	
0-150 ft (0-50m)	AWG 14 (2.5 mm ²)
>150 ft (> 50m)	AWG 12 (4 mm ²)

Specifications

Model	EX50Li 18"/46 cm	
Order#	EL5500 / EL5500-230	
Motor	0.8 Hp / 0.6 kW	
Runtime @ Max. Speed	DC: 90 minutes (four battery packs) DC: 45 minutes (two battery packs) AC: Unlimited	
Power AC	Universal Input: 85-264V 1Φ, 50/60 HZ	
Battery System	40V Lithium-ion, 432Wh, 12Ah	
IP Rating (Motor/Battery System/Controller)	IP66 / IP66 / IP66	
Dimensions (h x w x d)	22" x 21" x 12" in / 56 x 53 x 30 mm	
Weight	with two batteries: 54 lbs / 25 kg with one battery: 50 lbs / 23 kg without batteries: 45 lbs / 20 kg	
Operating Temp Range	-4°F to 105°F	-20°C to 40°C
Charge Temp Range	-32°F to 105°F	-0°C to 40°C
Approvals	CE AMCA	
AMCA Verified Airflow		
AC Power Supply	9,635 cfm (16,370 m ³ /hr)	
DC Power Supply	10,120 cfm (17,194 m ³ /hr)	



Control Panel

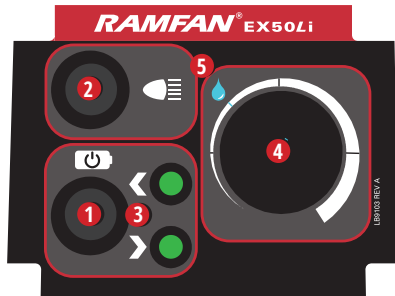

- 1 Battery Wake button
- 2 LED Scene Light
- 3 Battery Indicator Lights (L&R)
- 4 Speed Control
- 5 Mister Setting

Unit Description

The EX50Li is a multi-purpose 18"/46 cm ventilator powered by battery(s) or 85-264V single phase AC. The flexible frame configuration allows for PPV, Smoke Ejector or ducted blower use in both normal, horizontal and hanging positions. The fan can be tilted from 0-34° within the frame in PPV mode.

The motor, motor controller and batteries are water-resistant, IP66 rated.

The motor is a variable-speed BLDC motor controlled by a microprocessor integrated with a power supply, dual battery chargers and an LED light driver.

The EX50Li will run with one or two 40V 6Ah Li-ion battery packs. Each pack yields about 23 min of operation at full power. Extended operation is achieved by reducing speed. The batteries may be swapped during operation.

AC voltage can be applied while running on batteries and the ventilator will auto-switch to AC power. Conversely, the AC power can be removed and the unit will auto-switch to battery power, if sufficient charge remains.

The integrated battery chargers will charge one or two fully discharged battery packs in 4 hours or less.

LED scene lights are integrated into the fan shroud and have a high-low-off switch. Hold to change.

The integrated controller is EMI-protected to prevent interference with radio communication.

A simple Control Panel on the top of controller controls all functions.

Battery Operation

1. When AC is disconnected and Speed control is off, the controller and battery(s) will enter a sleep mode to conserve the battery power after 60 minutes of no activity.
2. To wake, push and briefly hold Wake button on control panel. Indicator lights will show battery status. The unit will return to sleep mode if not used within 10 minutes.
3. If Speed control is not in off position, return to off, and then advance as desired.
4. Blower will run on one or two battery packs. Two packs are used simultaneously and discharge evenly. Runtime is doubled with two packs. Indicator lights show battery charge state as in table. Indicator lights will turn red, then flash red as end of charge approaches. Batteries will disconnect at the end of their charge and blower will stop.
5. Battery(s) may be swapped for charged batteries at any time.
6. Reduce run speed to minimum required to increase runtime.











AC Operation

1. Set speed control to off position. The speed control must be off before the unit will run; a safety precaution to prevent an unwanted fan start.
2. Connect the fan to an AC power source. Indicator lights will automatically turn on, displaying battery charge level of each battery pack detected.
3. Power the fan on by adjusting the speed control to desired speed. *Note: The indicator lights will turn solid green and no longer display the battery charge status.*
4. When the fan is powered off, the indicator lights will redisplay battery charge level of each battery pack detected. The fan will begin charging the battery packs after 15 minutes of idle time.
5. Battery Packs do not charge while fan is running.

Charging

1. If both battery(s) and AC are connected, the battery(s) will begin charging after 60 minutes of idle time.
2. Indicator lights will show charge state during charging (See insert). Charging should complete in about 4 hours, with the Indicator lights turning green. Should the Speed control be turned on during the charge, charging will stop and the fan will start. Charging will begin again after 60 minutes of idle time.
3. After charging is complete, the chargers will maintain the battery(s) by keeping the blower connected to AC.
4. In service storage. Keep batteries topped by keeping blower connected to AC. Battery charge lights will go out as the controller and batteries are programmed to reduce leakage to a bare minimum. Use wake up button to check charge state.

Battery

		Fuel Gauge		
		LED Light	Approximate Run Time Remaining	
SOLID GREEN			Solid Green	81% to 100%
FLASHING GREEN			1 Sec Green Flash	21% to 80%
FLASHING RED			1 Sec Red Flash	6% to 20% (Prepare to Charge or Swap Battery)
SOLID RED			Solid Red	0% to 5% (Charge or Swap Battery)
OFF			OFF:	0%

NOTE: When the fan is running on AC Power, both indicator lights will be solid green.

NOTE: If the lights are off then the unit is in sleepmode or does not detect AC power.

NOTE: 1/2 Second, Rapid Red Flash Indicates Damaged or Faulty Battery Pack.

NOTE: The top light indicates the battery status for the battery connected on the left side of the fan. The bottom light indicates the battery status for the battery connected on the right side.

Battery (continued)

1. RAMFAN R2-360-AH-U lithium-ion battery packs are rated 40v 6Ah. The cells are Samsung 18650 rated 3Ah.
2. Factors affecting Performance and Cycle life.
 - Battery pack(s) should not be stored for longer than 12 months without charging, to maintain lifetime reliability.
 - Battery packs will last significantly longer when run in pairs; there will be a lower amp draw on each cell.
 - The number of discharge/charge cycles depends on how far down batteries are discharged; called the depth of discharge (DoD). Two battery packs with an average runtime of 20 minutes (50% DoD) or less will last significantly longer than two battery packs with an average runtime of 40 minutes (100% DoD).
 - As delivered, two new battery packs can power the blower for about 46 minutes. This decreases as the cycles pileup as shown in the table. Battery(s) will need to be replaced as they age.
 - Keep the blower attached to AC while not being used. This will keep them charged and lengthen their service life. An idle battery will slowly lose charge and possibly become unusable.
 - The number of discharge/charge cycles depends on Depth of discharge. Depth of discharge is the average capacity used per discharge. For example, 2 batteries with a 40 min capacity used for 20 minutes on average will be a 50% Depth of discharge (DoD). 1 battery with 20 min capacity run 20 minutes will be 100% DoD. The pair will last longer.

Depth of Discharge in minutes-2 pack	Discharge/Charge Cycles (Life)*
46 min.	250-500
20 min.	800+
10 min.	1500+

* Estimate only. Battery packs lose capacity as they are used. This number represents the number of cycles, after which the battery capacity has reduced to 60-70% of starting capacity, commonly time to replace. If battery capacity reaches less than what the user requires replace with new.

Maintenance

- DO NOT disassemble blower for maintenance reasons.
- Do not loosen screws on control box without contacting Euramco customer service. They are torqued to a setting to achieve water tightness.
- Clean fan periodically to remove accumulated dust or particles from fan guards, impeller blade and heat sink in rear of controller (ribbed). Use only biodegradable detergents. If power washing, avoid controller housing especially gaskets and control panel.
- Contact factory for replacement parts and installation instructions.
- Properly dispose of battery packs when necessary. Contact your local hazardous materials e-waste collection department for details or proper disposal of lithium-ion batteries.

Maintenance Schedule

After any significant impact or force on the battery (i.e. dropping, hitting, falling, etc.), user should inspect for potential gasket damage. Damage to gasket may compromise water ingress protection, increasing risk of pack failure. If any damage is identified during inspection, “R2 Gasket Kit” can be purchased for easy field maintenance, or at your nearest authorized service centers.

Do not store in same compartment with combustible or highly flammable material as gasoline and diesel oil.

Liquid damage is not covered under warranty.

REGULAR SERVICE PERIOD		After Each use	Every 3 months	Every 6 months	Every year
Perform at every indicated month or operating hour interval, whichever comes first.					
ITEM					
Fan Inlet/Outlet Gaurds	Visual Check	•			
	Clean			• (1)	
Impeller	Visual Check	•			
	Clean				• (1)
Control Box Gaskets	Visual Check	•	• (2)		
	Replace if necessary				• (3)
Electrical Cables	Check	•			•
Rubber Feet	Check				•
Battery Packs:					
Gaskets	Visual Check	•	• (2)		
	Replace if necessary				• (3)
Electrical Connector/USB Connector	Visual Check	•	• (2)		
Internal Diagnostics	Plug into USB if equipped				• (3)

- (1) Clean more frequently when used in high-sediment areas.
- (2) Check immediately if dropped, or damage may affect water ingress protection.
- (3) These items should be serviced by your RAMFAN servicing dealer, unless you have the proper tools and are mechanically proficient. Refer to RAMFAN service manual for service procedures. Failure to follow this maintenance schedule could result in non-warrantable failures.

Operating Limitations

RAMFAN lithium-ion battery packs are designed to operate in a wide range of temperatures. Due to the chemistry of lithium ion battery cells, different operational limits apply to discharge and charge functionality.

- Temperature range (discharge): -20°C to +45°C (-4°F to +113°F)
- Temperature range (charge): 0°C to +40°C (32°F to 104°F)

A “cold soaked” battery may not power a fan or be able to take a charge. If this occurs, warm up cold battery at room temperature 20°C (68°F) and try again.

Lithium-Ion Battery Maintenance Guidelines

Battery packs do require routine maintenance and care to maximize their useful life and maintain warranty coverage. Read and follow the guidelines in this manual to safely use your lithium-ion battery packs and achieve battery life span.

Overview

According to leading cell manufacturers (LG, Samsung, Panasonic), the estimated life of a lithium-ion battery is 500 charge cycles. When stating approximate useful life of a battery in units of “charge cycles,” cell manufacturers define this as the point where the battery capacity (Ah) is reduced to 80% of original. This means battery is not “dead” after 500 charge cycles, but runtime is significantly reduced, and replacement should be considered.

Partial discharge of lithium-ion batteries is fine. There is no “memory effect” and the battery does not need periodic full discharge cycles to prolong life.

Rehabilitation Operation

The RAMFAN EX50Li optional integrated misters are excellent for firefighter rehabilitation post fire. For optimal performance the fan should be set to approximately 1/3 maximum speed, marked by a blue line and water droplet on the speed control (see fig.1). The low velocity flow will maximize cooling while minimizing wetness. A water hose must be connected to the fan’s hose connection with water flowing before misting will occur.

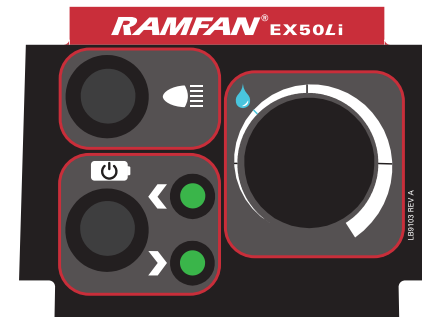

Figure 1



Compatibility

Date	Version	Serial Number (last 5 numbers)	Update
08/2017	1.1	77091 and higher	Shroud includes quick connect wiring harness needed for field installs of integrated mister. Note: Previous versions of fan (last 5 numbers of serial number are ≤ 77090 are ineligible for mister upgrade.

Accessories

1. External Battery Charger

Charge batteries on fire apparatus
Order # R2C-5500DC
Charge batteries at fire station
Order # R2C-5500AC
Order # R2C-5500AC230

2. Swappable 40V Li-Ion Battery Pack

Spare Battery (recommend ordering 2)
Order # R2-360-AH-U

3. Vehicle Mount Kit

Custom mount that perfectly fits fan
Order # EL600K

4. EX50Li Mister

Order # EL8111

5. Mister Adapters

Double Female NH 1" Adapters
Order# WF20-0252
1" BSP TO STORZ
Order# GX-8020

6. Convert to a Smoke Ejector

Door Bar and Hangar Kit
Order # EL7095K
Hanger Kit (if you already own door bar)
Order # EL8095

7. Convert to Confined Space Rescue Fan

18"/46cm duct (16.4'/5m length)
Order # FDT-185MSR
18"/46cm duct (32.8' / 10m length)
Order # FDT-181MSR

8. Shoulder Strap

Order # EL6013

Certification



FlowPath™ Control

AMCA



Euramco Safety Inc. certifies that the portable PPV Blowers shown here are licensed to bear the AMCA SEAL.

Euramco Safety Inc. certifies that the Portable PPV Blower shown below is licensed to bear the AMCA Seal. The ratings shown are based on tests and procedures in accordance with AMCA Publication 211 and comply with the AMCA Certified Ratings Program.

Why We Use AMCA

AMCA, The Air Movement and Control Association International, has been in existence for nearly 80 years and is the world's only recognized authority for the development of standards and measurement of air movement.

Our commitment to AMCA Certification is your verifiable assurance that every RAMFAN PPV Turbo Blower will perform exactly as specified.

SPECIFICATIONS AND PERFORMANCE RATINGS

MODEL	SIZE		HP	DIMENSION (HxWxD)		MOTOR MFG/MODEL N°	WEIGHT		RPM	SETBACK		ANGLE		AIRFLOW @ FULL SPEED		POWER SUPPLY
	in	cm		in	cm		lbs	kg		ft	m	tilt	cfm	m³/hr		
EX50Li	18	46	0.8	22x21x12	56x53x30	Euramco EM-E55010	45	20	2924	13.5	4.1	12.7°	9,635	16,370	AC	
EX50Li	18	46	0.8	22x21x12	56x53x30	Euramco EM-E55010	45	20	3045	14	4.3	9°	10,120	17,194	DC	

Performance certified is for installation type A - Free inlet, Free outlet.

Performance ratings do not include the effects of appurtenances (accessories).

RAMFAN's fire fighting PPV Series outperforms larger blowers in their class with their precision balanced TurboForce Impellers that maximize airflow. These PPV blowers have proven to be effective in controlling airborne contaminants, replacing interior air, removing heat and supplementing fixed ventilation systems. By pressurizing properly and controlling the resultant flow path, these changes occur very rapidly. This is accomplished by using these specialized blowers with the power and velocity to pressurize the interior of a structure or building.

August 2019



2746 Via Orange Way | Spring Valley, CA 91978 USA | (800) 472-6372 | (619) 670-9590

WWW.EURAMCO.COM

PROUDLY MADE IN CALIFORNIA



Parts Exploded View
EX50LI

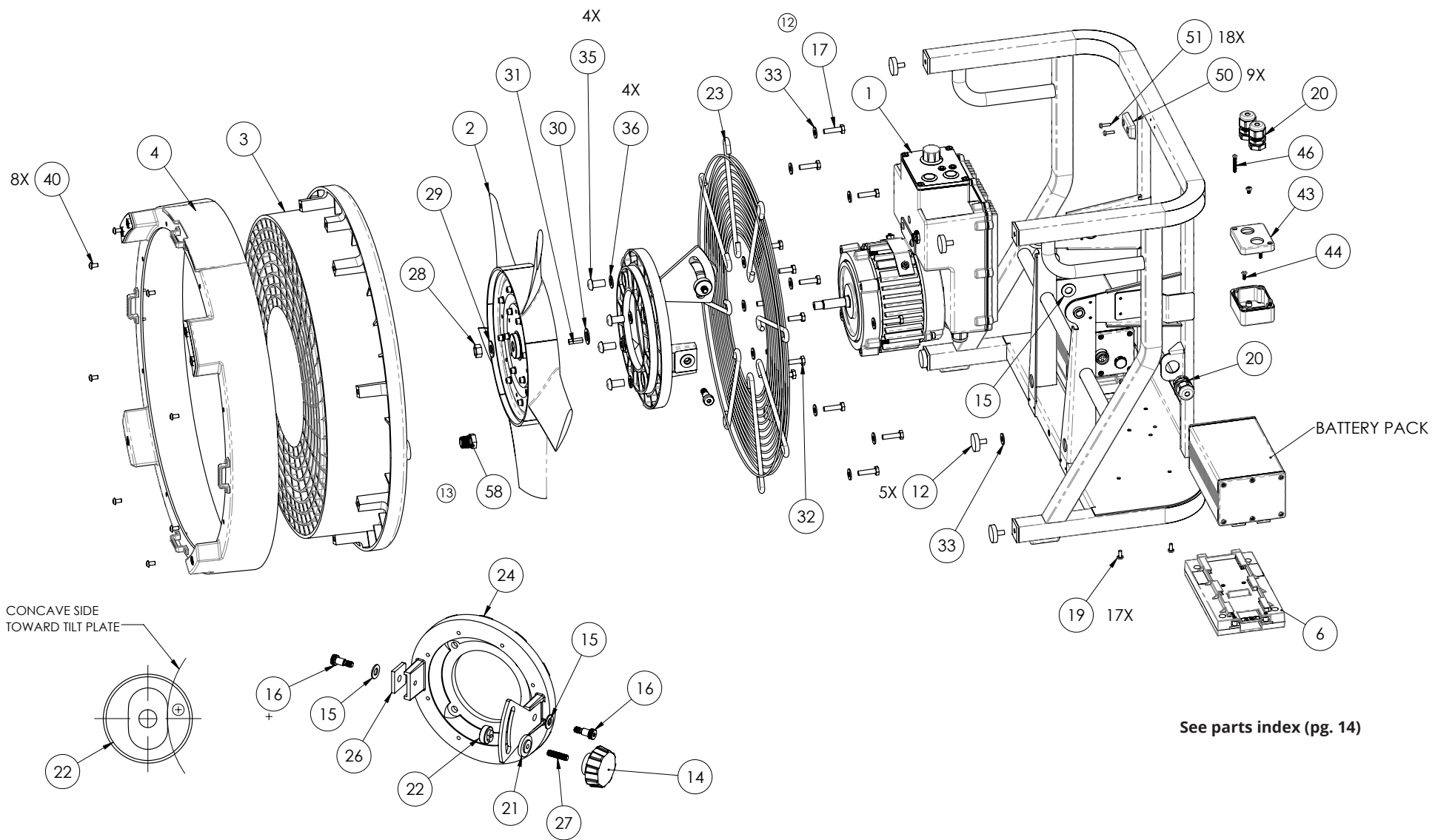

See parts index (pg. 14)

Parts Exploded View

EX50Li Index

Component Description	Bubble #	Part #
MOTOR/CONTROLLER ASSEMBLY 1	1	EMC-E55010
IMPELLER, 5 BLADE 17.65" 1.8HP@3800RPM	2	BL226
SHROUD, MOLDED, 18"/460mm	3	GH4015
EX50Li SHROUD COVER ASSEMBLY	4	EL2300
BATTERY MOUNT ASSEMBLY	6	R2-MOUNT360AHU
RUBBER FOOT, 50 DURO	12	FZ-MM9873
KNOB, 1/4-20 INSERT	14	FZ-KNOB-4210
3/8"X3/4" OD NYLON WASHER	15	FF99454
SHOULDER BOLT, 3/8 X .75, S/H	16	FZ-BOLT-A622
Capscrew, 1/4-20 X 7/8",H/H, Pltd Stl	17	FA9506520
SCREW, 8-32 x 3/8" PH,SEMS,EXT	19	FZ9502444
CABLE GRIP, FITTING (NON-X, PLASTIC)	20	EZ-PG11
WASHER, TILT SPACER, EX50Li	21	EL0151-101
CLAMP, TILT GUIDE	22	EL0151-100
GUARD,INLET, 18"FLAT	23	EL4001
SPACER BLOCK, TILT PLATE	26	EL-320004
STUD, THREADED 1/4-20 X 1.5"	27	FZ-98758A410
HEX NUT, 7/16-20, NYLOCK, THIN	28	FE96106NY
7/16" FLATWASHER, SAE, PLTD	29	FF96684SAE
1/2" FLATWASHER, SS AN960	30	FF91467AN960
KEY, 3/16" x .75"L IMP.	31	EA7020
Capscrew, 1/4-20 X 0.75, H/H, Pltd Stl GR5	32	FA9606480
1/4" FLATWASHER, SAE, PLTD. STL.	33	FF96439SAE
3/8 L/W STEEL	36	FG95450
Capscrew, 10-24 X 0.38, B/H	40	FZ9103459-BH
J-BOX, MACHINED	43	EL-RB32M
SCREW, 6-32 X 3/8" PAN PHIL PLTD STL	44	FZ9100505
#4-40 X 1" P-PAN, PLT STL.	46	FZ9600962
Rectangular Rubber Foot, Black, 64 duro.	50	FZ-TPRRF6
#6 x 1/2" P-TRUSS, SMS, PLTD STL.	51	FZ9500461-PT
PIPE PLUG, 3/8" NPT MACHINED	58	FH93816-MACH

Declaration of Conformity

DECLARATION OF CONFORMITY BATTERY POWERED FANS

Year of Manufacture: 2020

Manufacturer: Euramco Safety, Inc.
2746 Via Orange Way
Spring Valley, Ca. 91978 USA

Equipment Description: EX50Li – 18"/46cm Battery Powered PPV, Variable Speed, 85-250VAC (EL5500 / EL5500-230)
EX150Li – 18"/46cm Battery Powered PPV, Variable Speed, 85-250VAC (EL6500)

Standards to which
Conformity is Declared: 2006/42/EC – Machinery Directive
2014/35/EU – Low Voltage Directive
2014/30/EU – EMC Directive
2011/65/EU – RoHS – Reduction of Hazardous Substances
UN 3481 – Lithium-Ion Batteries when Packed with Equipment

Euramco Safety, Inc. hereby declares that the equipment described above conforms to the relevant Essential Health and Safety Requirements of the European Machinery Directive 2006/42/EC and the additional Directives and Standards listed above.



Wayne Allen
Wayne Allen
President and CEO

01/03/2020
DATE

Euramco Group | 2746 Via Orange Way, Spring Valley CA 91978 USA | Ph: +1-619-670-9590 | www.Euramco.com
Page 1 of 1



SM-EXS0LI REV F1
031722

USA

2746 Via Orange Way
Spring Valley, CA 91978 USA
Toll Free: (800) 472-6326
Phone: +1 (619) 670-9590
Fax: +1 (619) 670-7345
theteam@euramcosafety.com

LUXEMBOURG

1 Rue Edmond Reuter,
5326 Contern, Luxembourg
Phone: +352-621377200
Fax: +352-26008056
theteam@euramcosafety.com

MIDDLE EAST - UAE

Jebel Ali FTZ, Dubai
Phone: +1 (619) 670-9590 x114
Fax: +1 (619) 670-7345
theteam@euramcosafety.com

CHINA

A11, No. 1 Jinxi Road
Qingshuipu, Zhenhai, Zhejiang
Ningbo, China 315221
Phone: +86-574-87979390
Fax: +86-574-87979391
saleschina@euramcosafety.com