

Owner's Manual

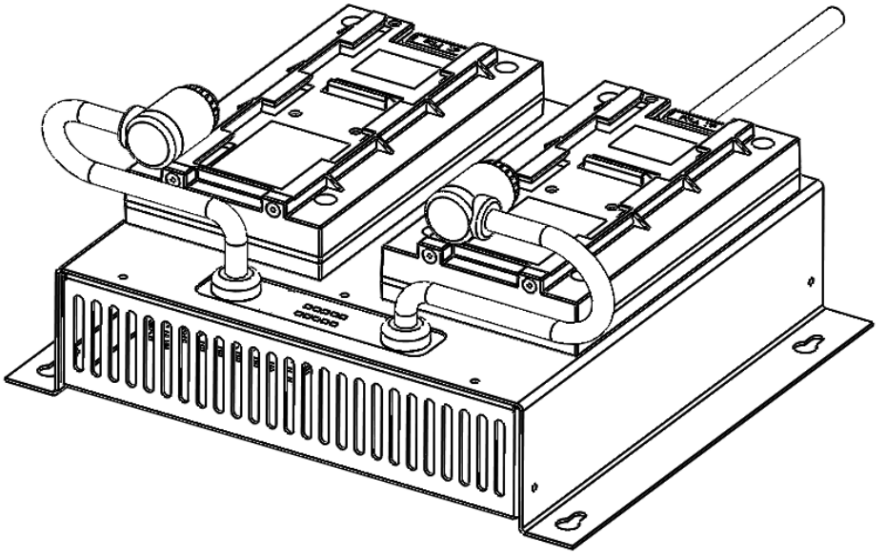

RAMFAN LITHIUM ION DUAL BATTERY RAPID CHARGER

Model Numbers:

R25515

Dual Battery Charger, 115/230VAC Input

R25515DC

Dual Battery Charger, 12-24VDC Input



**Euramco
Group**

Thank you for purchasing the RAMFAN® Dual Battery Charger manufactured in the USA by Euramco Group.

For more than 30 years Euramco Group has been on the cutting edge of industrial, fire, and marine ventilation products. Each of our blower/exhausters, smoke ejectors, PPV & LSV fans and accessories represent the finest technologies available. Every product is constructed to demanding and exact specifications for quality, performance, and reliability.

Explore our website and online catalog at www.ramfan.com and discover how RAMFAN products can make a difference in the field!

All product information in the publication is based on the most current information available at the time of printing. Euramco Group reserves the right to make changes at any time without notice.

General Safety Rules

1. SAFETY GUIDELINES

- Read and understand this manual before use.
- Always check charger, connection cable, extension cable and plug for damage and deterioration and repair as required before use.
- Keep the cables away from heat sources, oil and sharp edges.
- Store chargers outside the reach of children.
- Charger may not be exposed to rain or condensing humidity. Exposure to rain or condensing humidity can cause battery charger to malfunction and increase risk of shock hazards.
- Safe handling of the charger is only guaranteed if the safety and operating information are carefully read and adhered to.
- Do not use any chargers in an explosive environment such as in the vicinity of flammable liquids gases or dust.

2. USE AND CARE

- Take proper care of the charger. Keep an eye out for defective connections, defects and all other conditions that may affect the device's operation. If any damage, repair the charger before use.
- Battery pack(s) should not be stored for longer than 3 months without charging, to maintain longterm reliability.
- The Charger is for charging RAMFAN 40V, 6AH/7AH Li-Ion battery packs, part# R2-360-AH-U & R2-30V only.
- Battery packs should not be used in the vicinity of metallic objects such as paper clips, coins, nails, screws or other small metallic objects that could bridge and short out battery connection terminals.
- Improper use of battery packs can lead to fluid leaking from the battery; avoid any physical contact with the fluid. If you accidentally come into contact with this, wash the area concerned thoroughly with water. Seek medical assistance if the fluid gets into the eyes.

3. MAINTENANCE

- No user serviceable parts. Only allow qualified individuals to maintain the charger. This will ensure the long-term safety of the charger.

4. Alert

- Battery packs at temperatures above 105°F / 40°C or below 4°F / -20°C will not accept a charge.

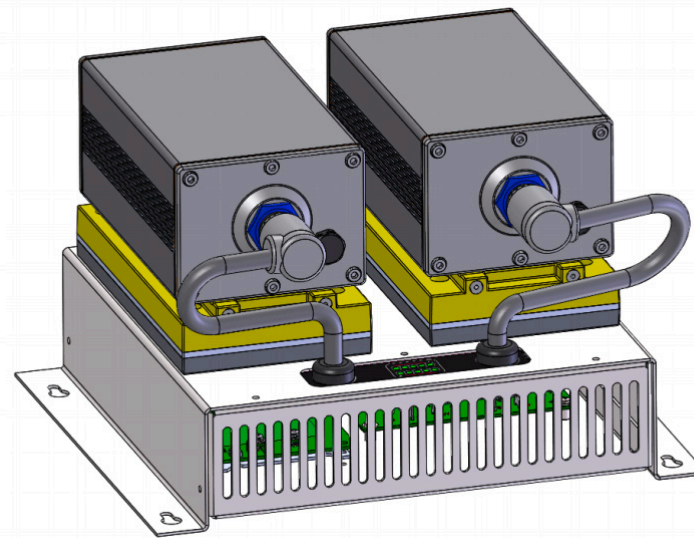

CONTENTS

| | |
|---|---|
| Basic Functions | 4 |
| Specifications | 4 |
| Installation | 4 |
| Charging Status | 5 |
| Electrical Connections | 5 |
| Back Pack Installation | 5 |
| Warranty | 6 |
| Customer Service | 6 |
| Disposal | 6 |
| EC Declaration of Conformity | 7 |
| Certifications | 7 |
| Mounting | 8 |

Basic Functions

- Microprocessor-controlled charging system, up to 6 hour charge time for RAMFAN 40V Li-Ion battery packs depending on the battery pack's discharge state
- Charge two RAMFAN 40V Li-Ion battery packs simultaneously
- Defective battery detection

Specifications

| | |
|---------------------------------------|--|
| MAX FULL AC LOAD: | 115VAC @ 2.6 AMPS, 299 WATTS 230VAC @ 1.3 AMPS, 299 WATTS |
| MAX FULL DC LOAD: | 12VDC @ 13 AMPS, 24VDC, 156 WATTS 24VDC @ 6.5 AMPS, 156 WATTS |
| OUTPUT: | Dual Channel, 42VDC, 3 Amps Charge Rate per Battery Pack Channel |
| CHARGE TIME: | 6 Hour Nominal |
| OVER-CHARGE PROTECTION: | Charger shuts down if Battery Pack charge current does not drop to 150 milliamps within 9 hours |
| UNDER VOLTAGE DISABLE: | Charger disabled if battery pack voltage is less than 6VDC |
| SIZE: (W X L X H) | 11-3/8" x 9-1/2" x 3-5/8" without Battery Packs 28.9 cm x 24.1 cm x 9.2 cm 11-3/8" x 9-1/2" x 6-1/2" with Battery Pack(s) 28.9 cm x 24.1 cm x 16.5 cm |
| WEIGHT: | 17 lbs (7.71Kg) with two Battery packs |
| OPTIMUM OPERATING ENVIRONMENT: | -20 °C to 50 °C, 95% RH |
| ROHS COMPLIANCE | 6/6 |

Installation

Determining the gauge [AWG] needed for the distance from the power source to the load, and back to the source of power.

| | | | | | | | | |
|---------|--------|--------|--------|--------|--------|--------|-------|-------|
| | 10 ft | 15 ft | 20 ft | 25 ft | 30 ft | 40 ft | 50 ft | 60 ft |
| 15 Amps | 16 AWG | 14 AWG | 12 AWG | 12 AWG | 10 AWG | 10 AWG | 8 AWG | 8 AWG |

- AC chargers are supplied with 6' power cable and are terminated with a NEMA #5-15 plug for 115V AC power or with a Schuko Cee 7/4" plug for 230V AC power
- DC chargers are supplied with 6' power cable with unterminated flying leads
- Find an area within reach of a power source
- Charger can be mounted onto vertical or horizontal surfaces
- Mounting location should have space for ventilation to ensure ambient temperature does not exceed 50°C
- Pick space such that the fan finger guard or vent holes and power cable entry are not blocked
- Pick a dry location
- Place the charger over desired mounting location
- Select four #10 or four 5mm self tapping or machine thread screws, not supplied with charger

Installation continued

- Determine appropriate through hole drill bit for select screws
- Drill four holes at mounting locations, and tap holes if required
- Install screws with screw head about 1/8" above mounting surfaces
- Hang charger onto the four screws
- Tighten screws to securely hold charger in place
- Select four #10 or four 5mm self tapping or machine thread screws, not supplied with charger

Batteries should not be stored for longer than 3 months without charging, to maintain "longterm reliability."

Charging Status

The charger will examine connected batteries' voltage

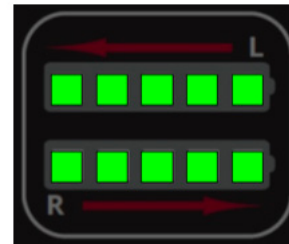

Battery Charge Display

Indicator Lights During Charge:

| | |
|---------------------|--|
| OFF | No battery detected. |
| RED FLASH | *Battery Fault |
| GREEN STROBE | Charging |
| STATUS | Solid  |

*Battery Fault - Battery failed to accept charge. Power to charger must be recycled to clear fault. This is a safety feature to prevent multiple charge attempts that could possibly damage battery. Call factory if battery will not accept charge.

Electrical Connections

Route and attach AC power cable plug to appropriate AC power receptacle, or route and attach DC power cable to an appropriate 12V DC or 24V DC power block.

Three models to support various input power application: 85-260V with NEMA plug, 85-260V with Schuko plug, and 12-24DC.

AC Models: Insert AC plug into the appropriate AC power receptacle. The AC input battery charger models are built around a universal (85 - 260AC, 50 / 60Hz) input power supply. Only the AC plug determines the input voltage to be 115VAC or 230VAC.

DC Models: Will work with 11-30VDC input.

Charger is not equipped with a power switch and is live when connected to power source. Charger automatically turns ON when input power is applied to the charger.

On power-up, charger will activate charge cycle once to check for sleeping batteries regardless of voltage of battery indicated by green strobing LED bar. Battery status LED's will be solid green when battery charge cycle is complete.

Battery Pack Installation

The battery charger will hold and charge two battery packs at one time. Charger will function with one or two battery packs installed.

Wait to attach battery cables until LED lights are off.

Align battery pack with holder and drive battery into position until a loud click is heard.

Attach charging cables to the battery pack(s).

Battery charger will determine if batteries are attached, measure & report battery charge/fuel level, and initiate a charge cycle.

Warranty

Battery Charger comes with a 12 month limited warranty. This does not cover damage due to improper handling. For information please visit www.RAMFAN.com.

Customer Service and Advice

The customer service department will answer your questions regarding repairs and maintenance for your product as well as regarding spare parts and operation. You can also find further information at www.RAMFAN.com.

Disposal

Charging devices, accessories and packaging should be recycled in an environmentally-friendly manner.

Only for EU countries: Do not dispose of charging devices in household waste. In accordance with the European Directive 2012/19/EC on Waste Electrical and Electronic Equipment and its implementation into national law, unserviceable chargers should be collected separately and recycled in an environmentally-friendly manner.

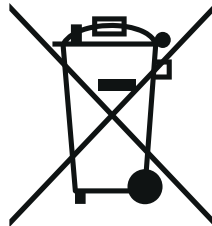



Environmentally Safe Battery Disposal

Battery pack(s) contain Li-ion, a toxic material. All toxic materials must be disposed of in a specified manner to prevent contamination of the environment. Before disposing of damaged or worn out Lithium-ion battery packs, contact your local waste disposal agency, or the local Environmental Protection Agency for information and specific instructions. Take the batteries to a local recycling and/or disposal center, certified for Li-ion disposal.



EC Declaration of Conformity

| DECLARATION OF CONFORMITY BATTERY CHARGERS | |
|---|---|
| Year of Manufacture: | 2019 |
| Manufacturer: | Euramco Safety, Inc. 2746 Via Orange Way Spring Valley, Ca. 91978 USA |
| Equipment Description: | R25515 – Universal AC Input, 42VDC @ 3 Amp Output R25515DC – 12-24VDC Input, 42VDC @ 1.5 Amp Output M16515 – Universal AC Input, 54.6VDC @ 3 Amp Output M16515DC – 12-24VDC Input, 54.6VDC @ 1.5 Amp Output BPV-12CE – 12V Battery Charger (EURO) |
| European Directives: | 2006/42/ EC – Machinery Directive 2014/30/EU – EMC Directive 2014/35/EU – Low Voltage Directive |
| Standards to which this Conformity is Declared: | BS EN ISO 13857:2008 – Safety Distances BS EN ISO 12100:2010 – Safety Machinery BS EN 6100-6-4:2007+A1:2011 – EMC Industrial Generic Emission BS EN 6100-6-2:2005 – EMC Immunity/Industrial Environments |
| Euramco Safety, Inc. hereby declares that the equipment described above conforms to the relevant Essential Health & Safety Requirements of the European Machinery Directive 2006/42/EC, and the Additional Directives and Standards listed above. | |
|  Jack Simmons | DATE 07/29/2019 |
|  | |

CERTIFICATIONS

| | | | | |
|-----------------------|----------------|--------------|------|------|
| CERTIFICATIONS | UN/DOT 38.3 | IEC 62133 | CNAS | WEEE |
|-----------------------|----------------|--------------|------|------|

Mounting

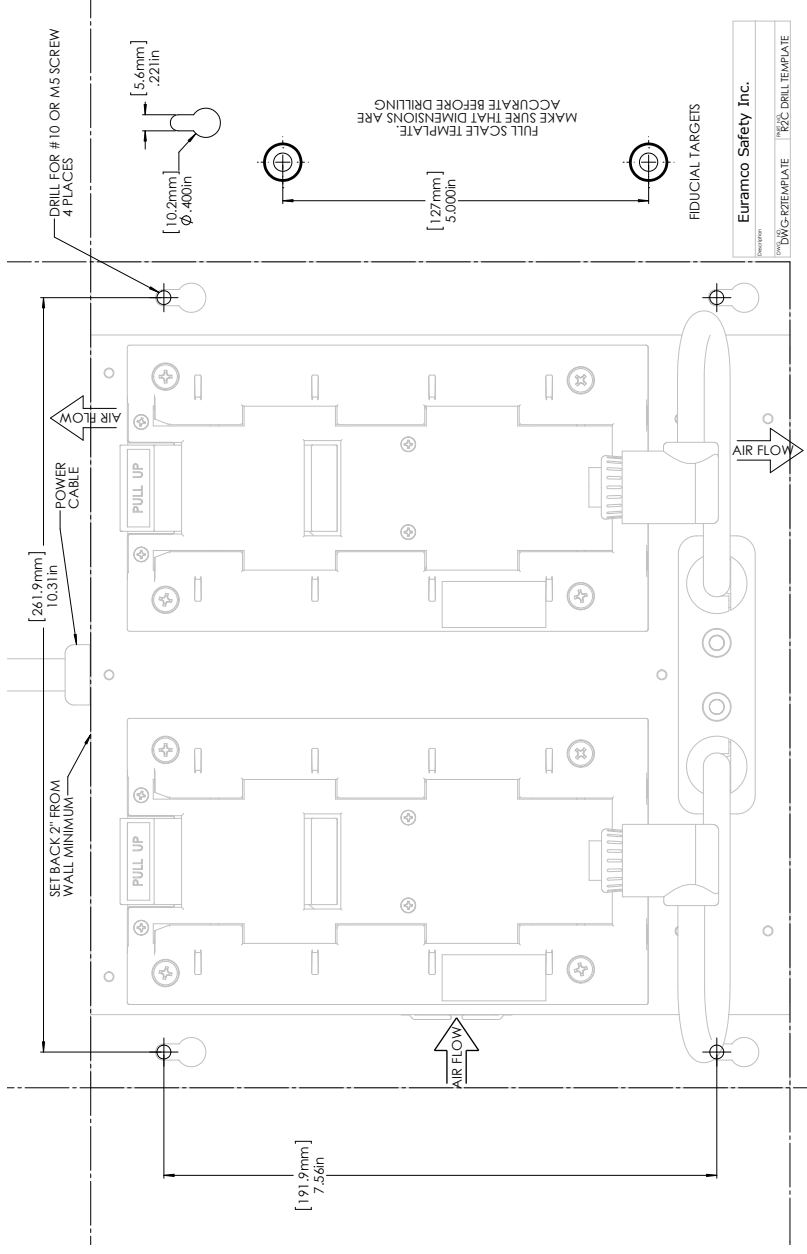



SM-R2C REV F5
110321

USA

2746 Via Orange Way
Spring Valley, CA 91978 USA
Toll Free: (800) 472-6326
Phone: +1 (619) 670-9590
Fax: +1 (619) 670-7345
theteam@euramcosafety.com

LUXEMBOURG

1 Rue Edmond Reuter,
5326 Contern, Luxembourg
Phone: +352-621377200
Fax: +352-26008056
theteam@euramcosafety.com

MIDDLE EAST - UAE

Jebel Ali FTZ, Dubai
Phone: +1 (619) 670-9590 x114
Fax: +1 (619) 670-7345
theteam@euramcosafety.com

CHINA

A11, No. 1 Jinxi Road
Qingshuipu, Zhenhai, Zhejiang
Ningbo, China 315221
Phone: +86-574-87979390
Fax: +86-574-87979391
saleschina@euramcosafety.com